

56305-03	1
56315-03	1
58211-03	1
55325-03	3
10480-03	5
15325-03	3
57305-03	1
57315-03	1
09820-03	2
09840-03	1
09815-03	1
09855-03	1
09835-03	2
09845-03	2
09879-03	1
09805-03	1
11491-03	1
57305-03	1

1

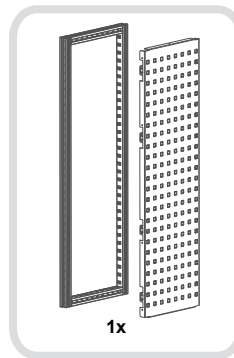

A

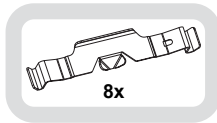
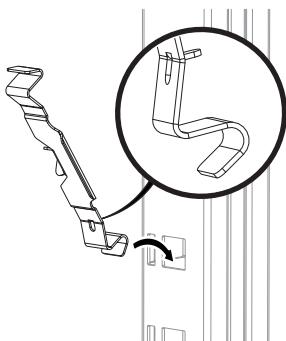

B

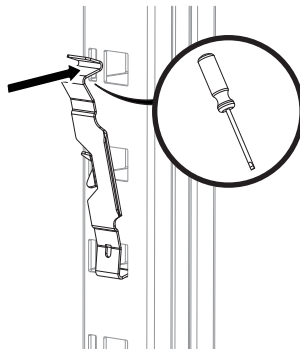

C

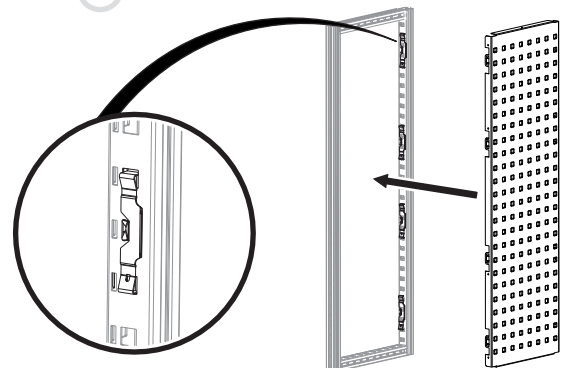

2

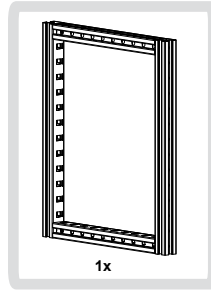
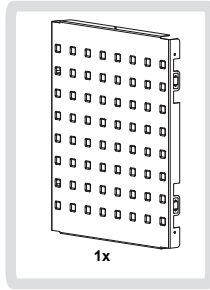
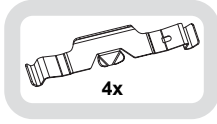

A

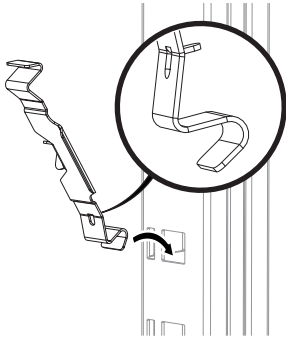

B

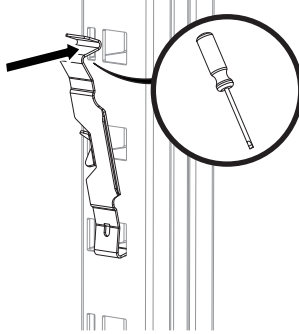

C

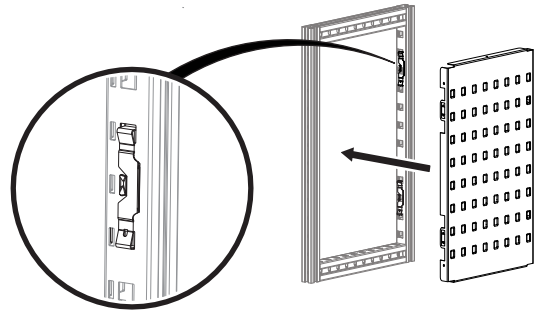

3

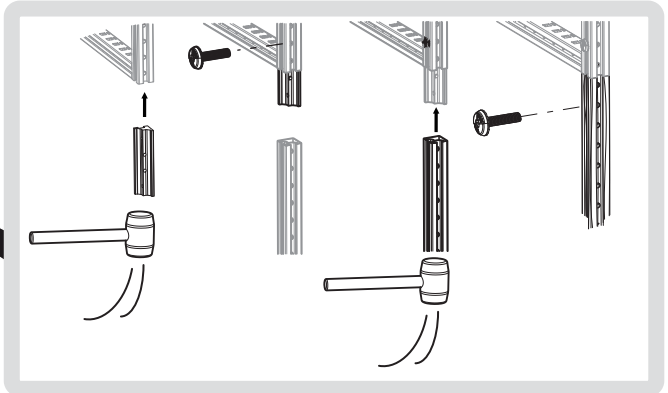
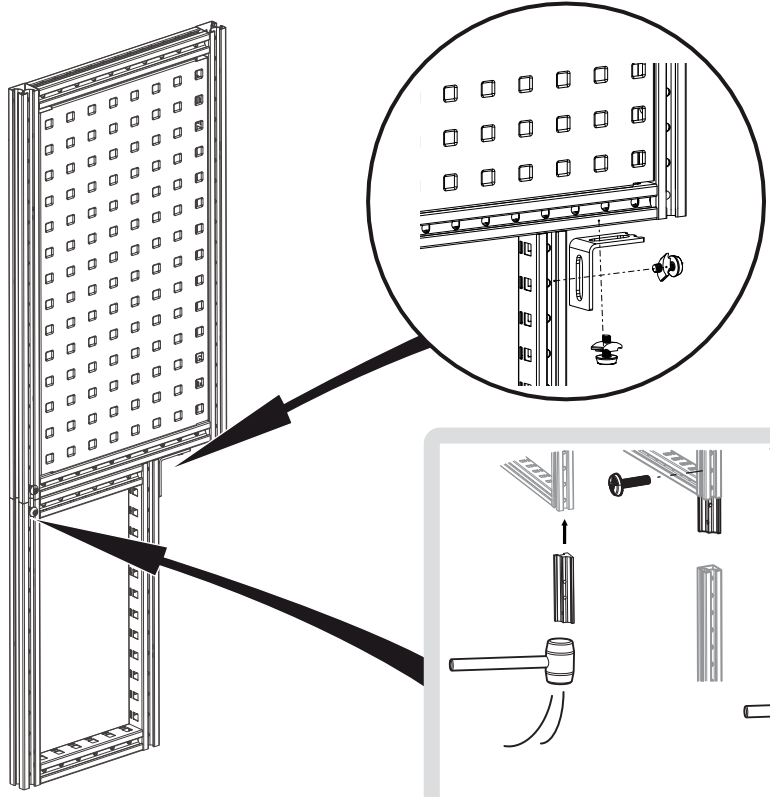
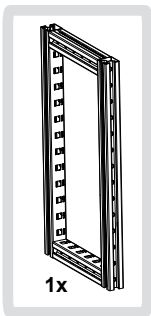
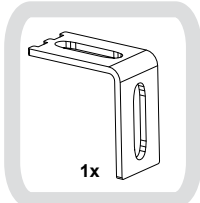
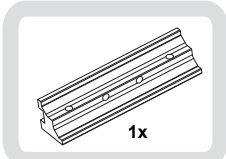
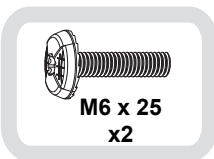
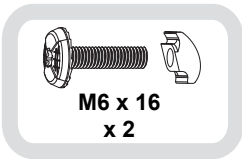



M6 x 35  
x 12

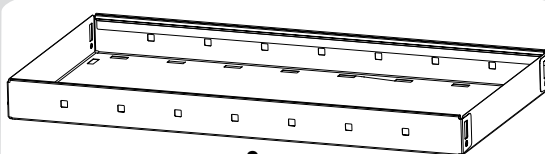

x 3

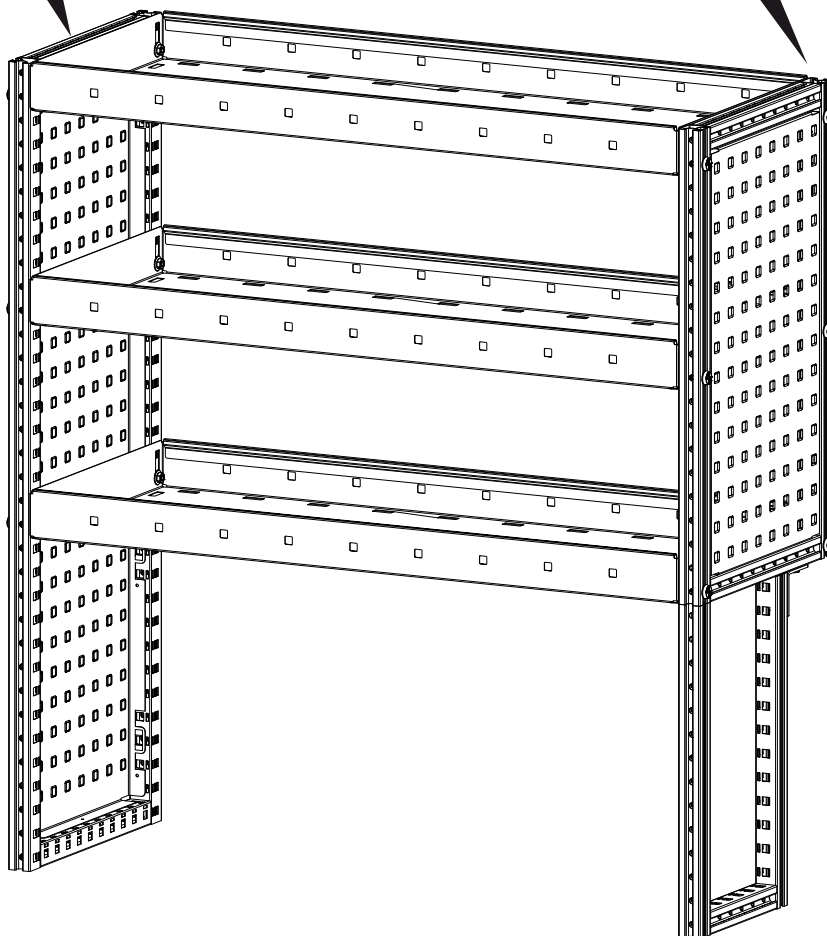
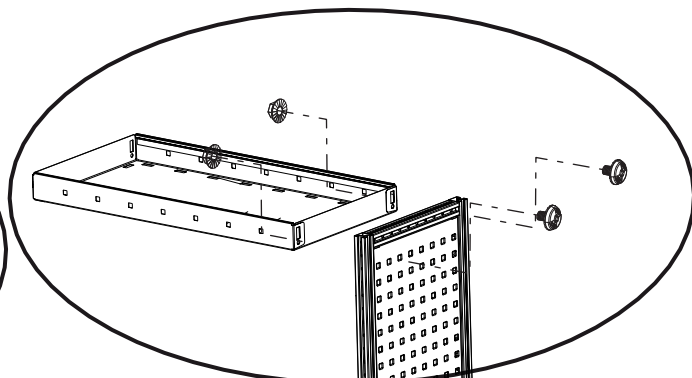
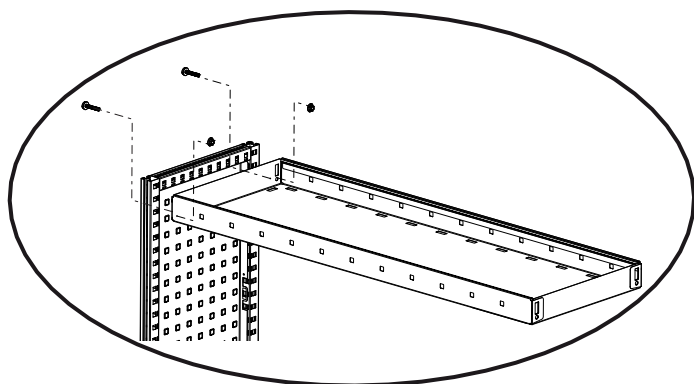

4



M6 x 16  
x 2

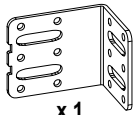

x 1

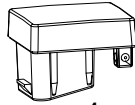

x 4

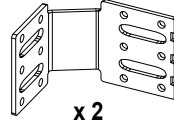

x 2



x 3



M6 x 40  
x 16

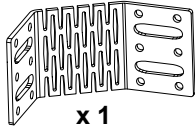

x 1

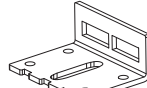

x 2

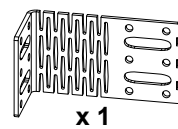

x 1

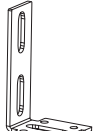

x 2



M6 x 16  
x 2

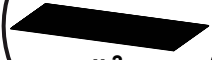
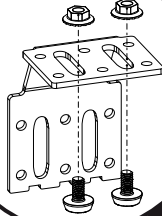

x 3

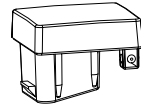

x 4

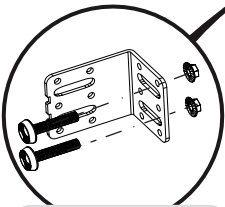

M6 x 40  
x 4

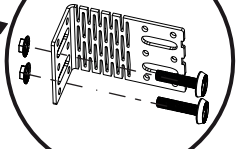
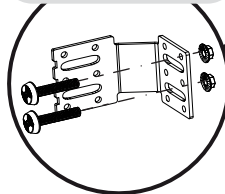

M6 x 40  
x 4

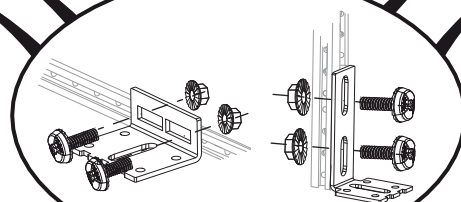
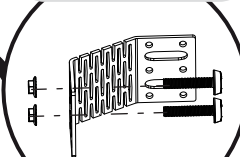

M6 x 40  
x 8

### M6

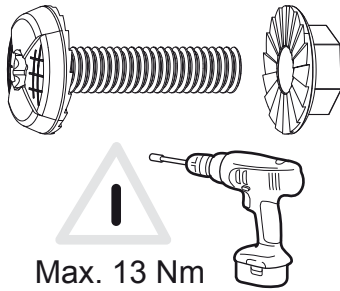

### M8

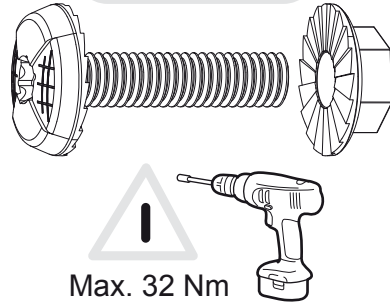

### M6

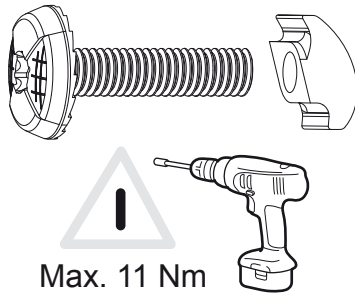

### 5x12

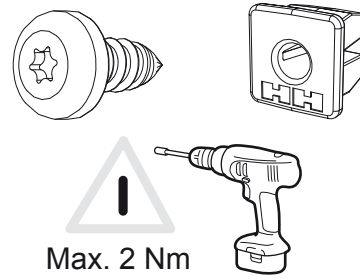

1

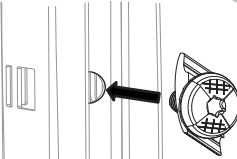

2

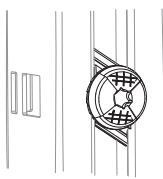

3

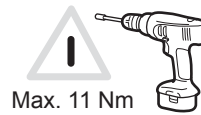
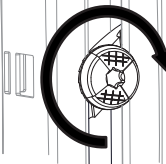

Ø 6,5 mm