



Owners Manual

e-Heater



Service Contact Information

E-mail: info@modul-system.com

Phone: +46 31 746 87 00

Web: www.modul-system.com

Revision: 1.1

Date: 2024-12-17

For safe and optimum performance, the e-Heater must be used properly. Carefully read and follow all instructions and guidelines in this manual.

PLEASE KEEP THIS MANUAL FOR FUTURE REFERENCE

Disclaimer

While every precaution has been taken to ensure the accuracy of the contents of this guide, Modul-System assumes no responsibility for errors or omissions.

Note: As well that specifications and product functionality may change without notice.

Important

Please be sure to read and save the entire manual before using your Modul-System **e-Heater**. Misuse may result in damage to property or the vehicle and/or cause harm or serious injury.

Product Numbers

28410-03 e-Heater 1000
28420-03 e-Heater 2000

Optional parts:

Control

24000-042 Modul-Connect Hub starter kit
28201-03 RJ45 Modul-Connect connection cable (2 meters)

Auxiliary battery and control

28220-03 e-Power 2000
28221-03 e-Power 2000 X-treme

Installation

28411-03 Battery Cables 3m for e-Heater 1000
28421-03 Battery Cables 3m for e-Heater 2000
28412-03 Shelf Bracket for e-Heater
28413-03 Hose kit 2m for e-Heater
28414-03 Hose kit 4m for e-Heater

Innehåll

1. Introduction	3
1.1 Important safety information.....	3
2. Product description	6
2.1 Front	6
2.2 Rear.....	7
3. Installation	8
3.1 Ducting.....	8
3.1.1 Grill ducting	8
3.1.2 Hose ducting.....	9
3.2 e-Heater Connection to Battery	10
3.3 e-Heater Connection to Modul-Connect.....	12
.....	12
3.4 Installation in vehicle.....	14
3.4.1 e-Heater Shelf bracket (28412-03).....	14
4. Controlling the heater	16
4.1 Control knob	16
4.2 Modul-Connect	16
4.2.1 Phone app.....	16
4.2.2 Switch Panels.....	17
4.2.3 e-Power	18
5. Technical Specification	19
6. Warranty	20

1. Introduction

Welcome to the User Manual for the e-Heater 1000 and e-Heater 2000. This manual is intended to provide comprehensive guidance on the installation, operation, and maintenance of your new heater, ensuring optimal performance and longevity.

Please note, the heater must in all cases be powered from an additional battery bank and NOT DIRECTLY from the vehicles Chassis battery.

Purpose of this Manual

This manual provides detailed instructions and essential information, including:

1. Safety Information
2. Installation Procedures: Step-by-step guidance on how to properly install the heater.
3. Operating Instructions: Detailed descriptions of how to use and control the heater effectively.

Customer Support

Should you encounter any issues or have any questions not covered in this manual, our dedicated customer support team is available to assist you. Contact information and support resources can be found in the final section of this manual.

1.1 Important safety information

Please read and follow all safety instructions and warnings provided in this manual to prevent accidents and ensure safe operation. Improper installation or use of the heater can result in serious injury or damage.

Before using the Modul-System e-Heater, read all instructions and cautionary markings on or provided with the heater and in this guide.

Heater Technology:

- **PTC Heaters:** The e-Heater uses Positive Temperature Coefficient (PTC) heaters to warm the air, these heaters are electrically insulated, making them safer than traditional heaters with metallic wires or ceramic elements.
- **Self-Regulating and Self-Limiting:** PTC heaters adjust their temperature independently and cannot exceed their maximum designed temperature, eliminating the need for additional overheat protection.
- **Safety Housing:** The PTC heaters are housed in a non-conductive, temperature-resistant casing.
- **Polarity protection:** The heater features built-in protection against polarity reversal.

DANGER: Fire and Burn Hazard

- Do not cover or obstruct air vent openings.

- Do not install in a zero-clearance or restrictive area.
- Failure to follow these instructions can result in death or serious injury.

Usage Guidelines

- Designed for utility-style light commercial vehicles.
- Ensure the fan is running when the heater is in operation.
- Supervision required for children or those with restricted ability.
- Do not cover the heater or place flammable materials near it.
- Avoid using the heater in dusty or contaminated air environments.
- The heater casing and output ducting can become hot during use.
- Securely fix additional output ducting away from combustible materials.
- Position power leads to avoid damage or stress.
- Do not operate with damaged cables or plugs; replace immediately.

Safe Installation and Operation

- Avoid placing air inputs and outputs near:
 - Animals
 - Children
 - People with sensory disabilities
 - Flammable materials
 - Flammable liquids or gases
 - Temperature-sensitive items

Hazardous Environments

- Avoid overly wet, damp, or dusty environments.
- Keep away from airborne contaminants and flammable liquids or gases.

Special Safety Regulations

- Operate the heater under supervision; do not leave unattended for long periods.
- Keep face and eyes away from heater output; use PPE if necessary.
- Do not expose to snow or liquids.
- Heater may take longer to heat in very cold temperatures.

DANGER: Shock Hazard

- Avoid inserting metal objects into the heater casing.
- Disconnect the main power plug before disconnecting any cables.
- Do not modify the heater's internal electrical system without approval.
- Have someone nearby when installing or servicing electrical equipment.

DANGER: Explosion Hazard

- Do not use the heater near flammable fumes or gases.
- Ensure good ventilation around the heater.
- Maintain at least 80mm free air gap to the front and rear of the heater to allow for free air flow.
- Avoid prolonged exposure to high heat or freezing temperatures.

Waste Electrical and Electronic Equipment Recycling (WEEE)

- Do not dispose of electrical appliances as unsorted municipal waste.

- Use separate collection facilities for disposal.
- Contact local government for information on collection systems.

CE EMC Information

- This equipment complies with CE and UKCA standards for residential installations.

Limitations on Use

- Do not use in connection with life support systems or other medical equipment.

2. Product description

The Modul-System e-Heaters are designed to efficiently heat both the load area and cab of your vehicle completely emission free. It is ideal for all light commercial vehicles (LCVs), particularly electric and hybrid models, including Battery Electric Vehicles (BEVs), Hybrid Electric Vehicles (HEVs), Plug-In Hybrid Electric Vehicles (PHEVs), and Range Extended Electric Vehicles (REEVs).

The e-Heaters does not require solid fuel or an external exhaust, making it suitable for installation in any racking unit within the vehicle. You can mount it in any position and orientation that does not violate OEM no-drill areas. The heater is compatible with various battery types, though AGM or Lithium batteries are recommended over lead-acid ones

2.1 Front

1. Heat outlet
2. Control knob
3. LED indicators



Figure 1 Front of the e-Heater 2000

*e-Heater 1000 has one heating outlets, whilst the e-Heater 2000 has two heating outlets.

2.2 Rear

1. 12vdc Negative In
2. 12vdc Positive in
3. CAN communication port

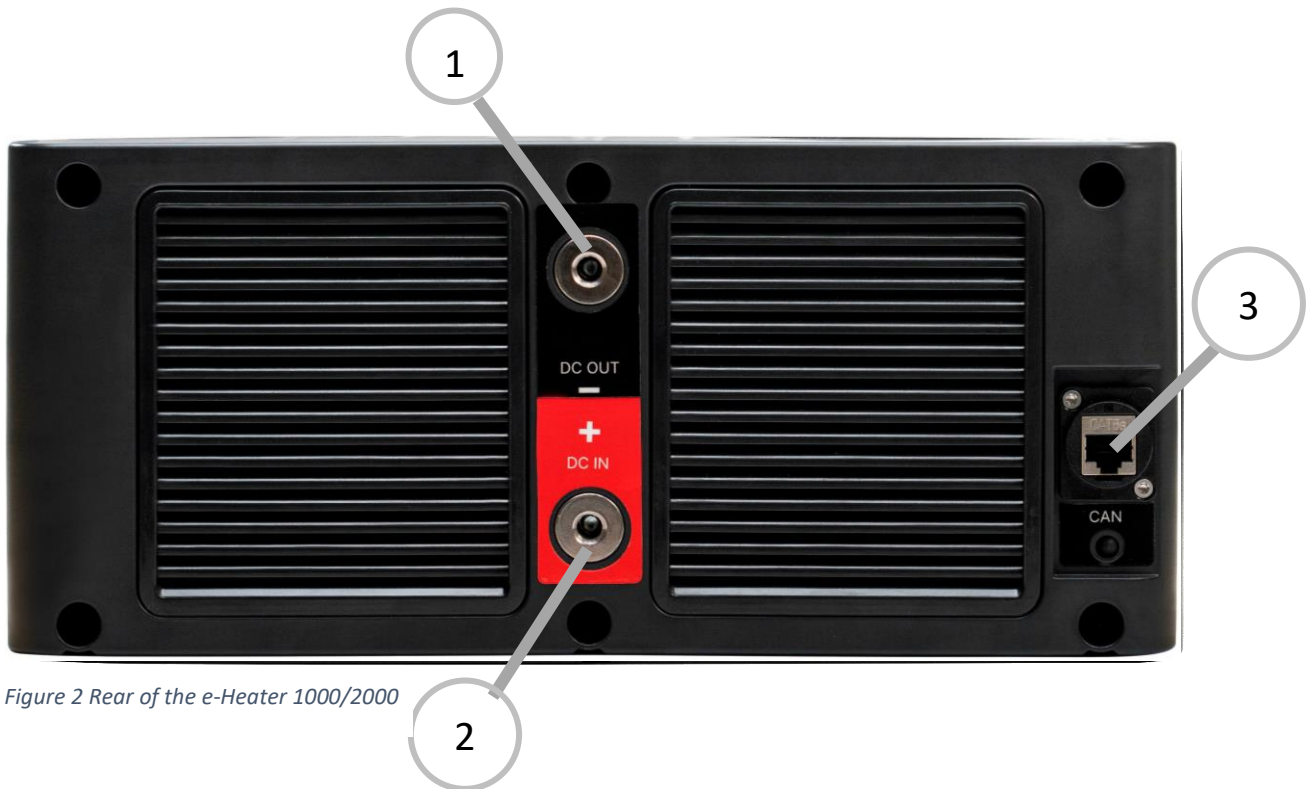

Figure 2 Rear of the e-Heater 1000/2000

This heater must in all cases be powered from an additional battery bank and NOT DIRECTLY from the vehicles Chassis battery.

3. Installation

WARNING: Modul-System recommends that all wiring be done by a certified Technician or Electrician to ensure adherence to the applicable electrical safety wiring regulations and installation codes. Failure to follow these instructions can damage the unit and could also result in personal injury or loss of life.

CAUTION: Before beginning your installation, please consider the following:

- The e-heater must in all cases be powered from an additional battery bank and NOT DIRECTLY from the vehicles Chassis battery.
- The e-Heater unit is configured for optimum operation with any additional AGM, Lithium, or lead acid batteries.
- The e-Heater should be used or stored in an indoor type of area, away from direct sunlight, heat, moisture, or conductive contaminants.
- When installing the unit, allow a minimum of 80 mm of space to the front and rear for the heater to allow for free air flow.
- The e-Heater does not require a solid fuel supply or any external exhaust requirements, therefore can be fitted in any Racking unit in a suitable mounting position and orientation in the vehicle with no holes required in the vehicle floor that contravene OEM vehicle manufactures no-drill areas.

NOTE!

- **Modul-System recommends you purchase as much auxiliary battery capacity as possible.**
- **Modul-System recommends you purchase the correct charging infrastructure for the auxiliary battery system.**

The e-Heaters are configured for optimum operation with any battery although AGM or Lithium are recommended over the use of lead acid or 'Leisure' type batteries.

3.1 Ducting

The e-Heater offers two ducting options: one for heating the space where the e-Heater is located and another for attaching a hose to direct heat to a different area.

3.1.1 Grill ducting

The e-Heater comes with one grill for each outlet. To attach the grill, align the spikes with the holes around the outlet and press it into place.

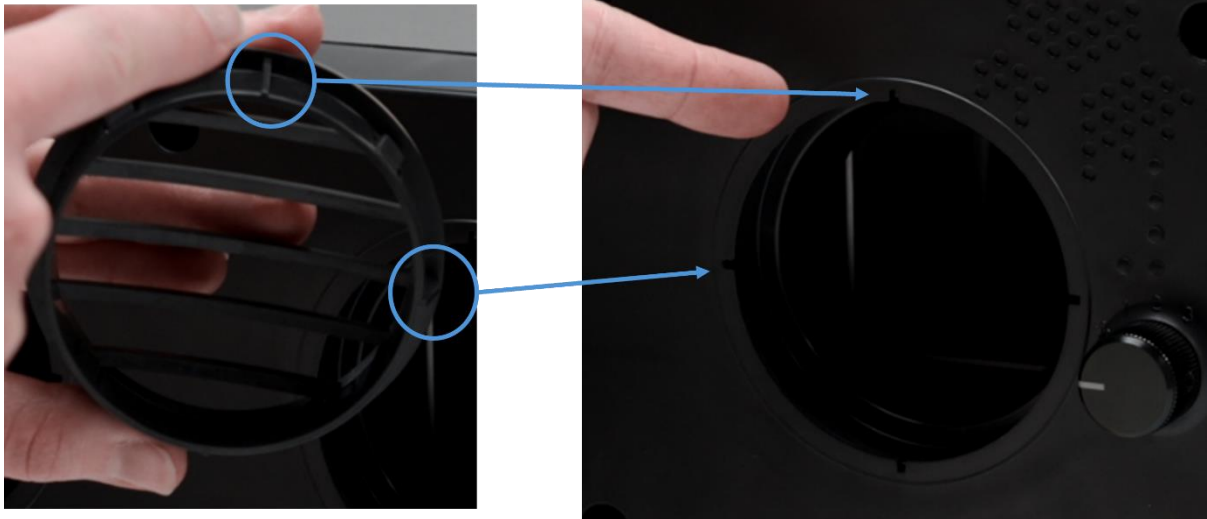

3.1.2 Hose ducting

With 28413-03 Hose kit 2m for e-Heater or 28414-03 Hose kit 4m for e-Heater, a hose can be attached to an outlet to duct the heat to a different area.

The kits consist of:

- 1 x Air vent outlet for hose
- 1 x Neoprene Heater ducting 2m/4m
- 2 x Hose clamp 50-70mm
- Triple ball vent 50mm

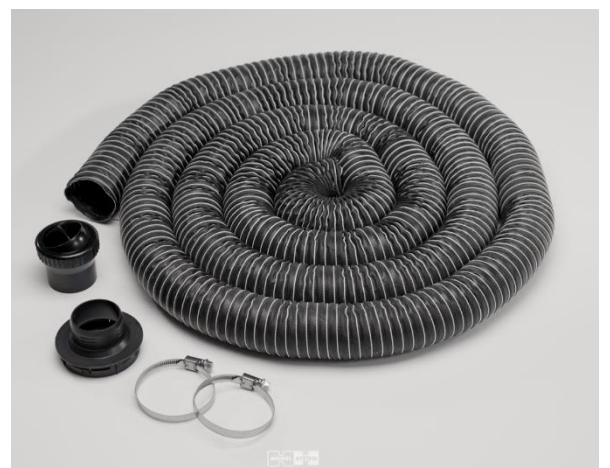

1. Slide a hose clamp onto one end of the hose.
2. Attach the air vent outlet to the hose securely.
3. Position the clamp so it covers both the hose and the air vent connection, then tighten it firmly.
4. Check to ensure the hose is securely attached and does not disconnect from the air vent.
5. Attach the air vent outlet to one of the heater outlets by align the spikes with the holes around the outlet and press it into place.
6. Repeat the process for the Triple ball vent after



Figure 3 Air vent outlet



Figure 4 Triple Ball vent

3.2 e-Heater Connection to Battery

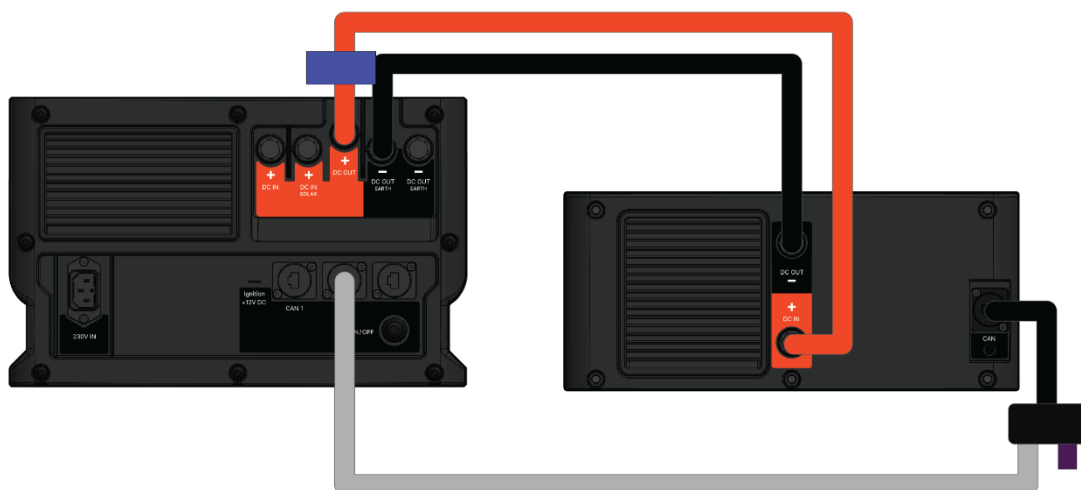

Figure 5. e-Heater wired to the lithium battery bank 28220-03 e-Power 2000

Cabling, fuse and fuse holder are not supplied with the e-Heater but can be purchased under separate part numbers, see table 1.

Fuse or Circuit Breaker:

- **The e-Heater 1000** must be fitted with 1 off in-line 100 amp fuse for the main battery connection on the positive +12 volt supply.
- **The e-Heater 2000** must be fitted with 1 off in-line 200 amp fuse for the main battery connection on the positive +12 volt supply.
- The 100 amp/200 amp DC-rated fuse and holder is required at the DC positive source to protect the cable run.

Cable:

If the cord of the heater is damaged, it must be repaired by manufacturer or qualified electrician.

- **The e-Heater 1000** must be connected with input (Red) 25mm² cables.
- **The e-Heater 2000** must be connected with input (Red) 40mm² cables.
- Use low resistance cable for all the DC connections between the e-Heater and the battery bank.

Control/Communication:

When installing any version of the Modul-System e-Power with an e-Heater, you must also connect an RJ45 to RJ45 CAN cable, an RJ45 splitter, and a terminator in the CAN ports on the back of the units. The terminator should be placed at the end of the line, farthest from the e-Power unit, which requires connecting the RJ45 splitter to the e-Heater, as shown in Figure 6.

1. Plug in the RJ45-to-RJ45 cable into the CAN1 or CAN2 port in the rear of the e-Power.
2. Plug the other end of the RJ45 cable into the RJ45 splitter
3. In the other port of the RJ45 splitter, plug-in the terminator supplied with the e-Power.
4. Connect the RJ45 splitter to the CAN port in the rear of the e-Heater.



Figure 6 CAN communication between e-Power and e-Heater

Note! Only CAN1 and CAN2 can be used on the e-Power. CAN 3 is a diagnostics port – do not use.
Note! The termination is included with the e-Power.

Part number	Name
28411-03	Battery cables 3m for e-Heater 1000
28421-03	Battery cables 3m for e-Heater 2000
28204-03	RJ45 CAN Cable e-Power 0.5m
28205-03	RJ45 CAN Cable e-Power 2m
28207-03	RJ45 Splitter

Table 1.

3.3 e-Heater Connection to Modul-Connect

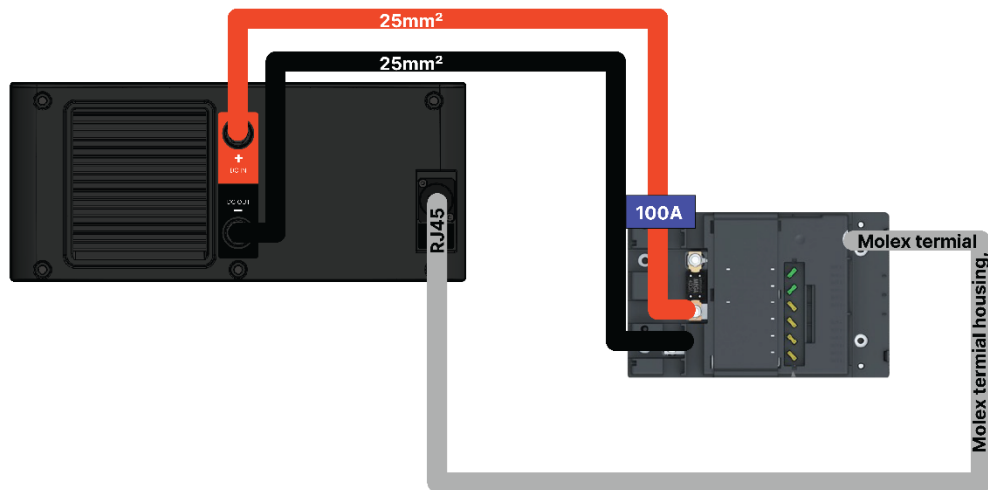

Figure 7 e-Heater 1000 powered via Modul-Connect

Figure 7. shows an installation where the e-Heater is powered via Modul-Connect. This is not required to be able to control the e-Heater via Modul-Connect. When powering the e-Heater from a different power source, only read the 'Control/communication' part.

Fuse or Circuit Breaker:

- **The e-Heater 1000** must be fitted with 1 off in-line 100 amp fuse for the main battery connection on the positive +12 volt supply.
- **The e-Heater 2000** must be fitted with 1 off in-line 200 amp fuse for the main battery connection on the positive +12 volt supply.
- The 100 amp/200 amp DC-rated fuse and holder is required at the DC positive source to protect the cable run.

Cable:

If the cord of the heater is damaged, it must be repaired by manufacturer or qualified electrician.

- The e-Heater 1000 must be connected with input (Red) 25mm² cables.
- The e-Heater 2000 must be connected with input (Red) 40mm² cables.
- Use low resistance cable for all the DC connections between the e-Heater and the battery bank.

Control/Communication:

To control the e-Heater via Modul-Connect, the RJ45 Modul-Connect connection cable needs to be connected between the CAN port on the e-Heater and the Molex output pins for CAN1 and GND as in the figure below.

Pin 1 External IN/OUT *500mA max	Pin 2 External IN/OUT *500mA max	Pin 3 External IN/OUT *500mA max	Pin 4 External IN/OUT *500mA max	Pin 5 External IN/OUT *1A max	Pin 6 CAN 3 H	Pin 7 CAN 2 H	Pin 8 CAN 1 H
Pin 9 External IN/OUT *500mA max	Pin 10 External IN/OUT *500mA max	Pin 11 External IN/OUT *500mA max	Pin 12 External IN/OUT *500mA max	Pin 13 GND	Pin 14 CAN 3 L	Pin 15 CAN 2 L	Pin 16 CAN 1 L

Part number	Name
28411-03	Battery cables 3m for e-Heater 1000
28421-03	Battery cables 3m for e-Heater 2000
28201-03	RJ45 Modul-Connect connection cable (2 meters)

App setup

1. Go to 'Manage vehicle', scroll down to 'Add accessories' and choose the correct heater under 'Heating system'.
2. Choose a battery guard. This setting determines at what battery voltage limit the heater should automatically turn off to protect the battery. This battery guard is based on the battery powering the Modul-Connect hub, if the heater is powered from another source, choose 'None'.
3. Select which CAN input the heater is wired into. CAN1 is the default for heaters.
4. Press save. A switch and widget for the heater is then available on the start screen.

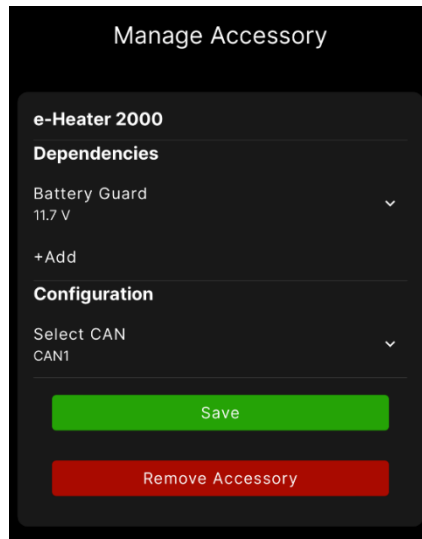
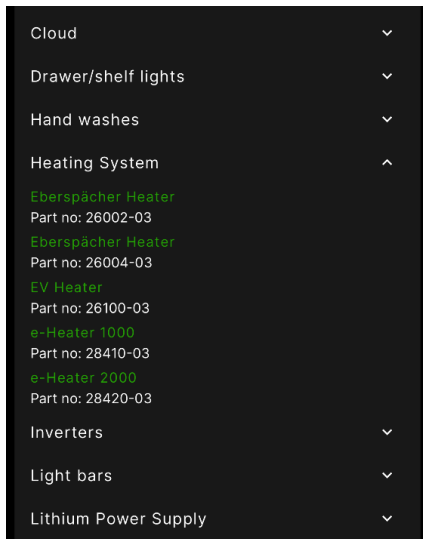

3.4 Installation in vehicle

1. Choose an appropriate mounting location.
2. Ensure All fuses, fuse holders and connecting cables are the correct gauge to the product and position.
3. The e-Heater must be securely mounted on a metal or non-combustible surface.
4. It is recommended to use a minimum of 4 off M6 fixings to secure the e-Heater.

3.4.1 e-Heater Shelf bracket (28412-03)

To fit the heater under a shelf, facing the centre of the vehicle, the 28412-03 Shelf bracket for e-Heater is needed. Screws and bolts are included with the bracket.

1. Screw the shelf brackets to the t-tracks on the left and right side of the e-Heater, using the included screws and nuts.
2. Place the heater under the shelf and screw into the t-tracks on top of the heater.

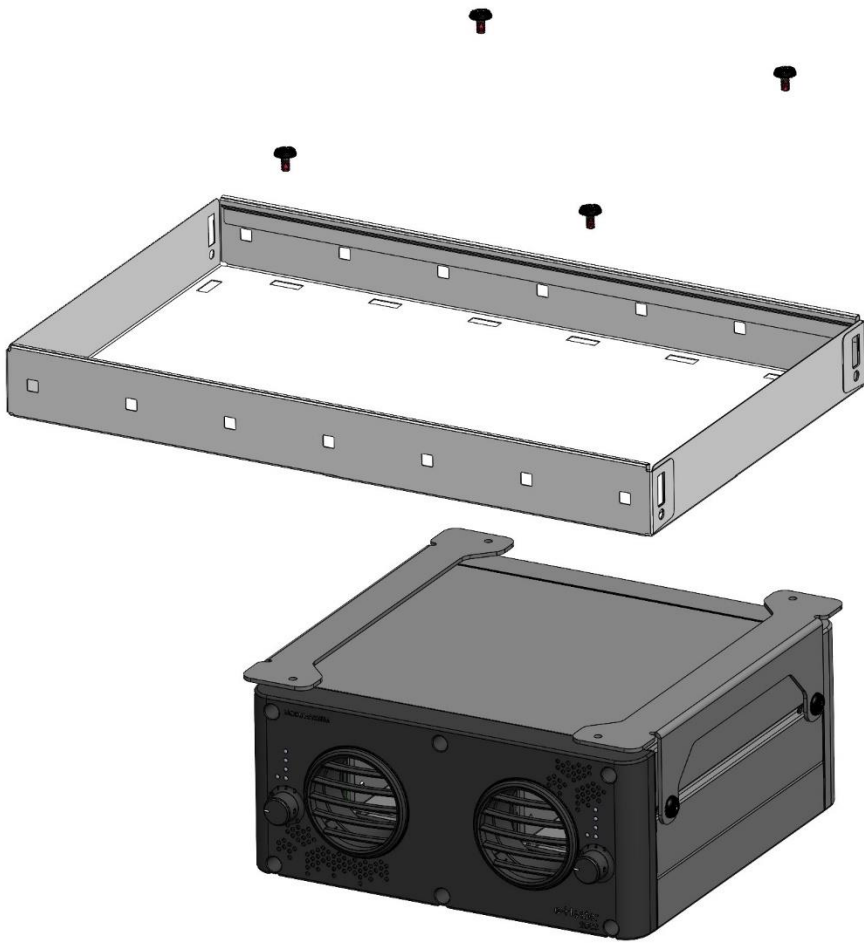

Figure 8 e-Heater shelf bracket installation

4. Controlling the heater

There are three different options on how to control the e-Heater.

4.1 Control knob

The e-Heaters can be managed using control knobs located on the front of the unit. By turning the knobs, the heater can be set to different target temperatures. The e-Heater will operate at full power until the set temperature is achieved. Once the target temperature is reached, the unit will lower its power and maintain the temperature within the vehicle.

The target temperatures are as follows:

Fan = Only the fan starts

1 = 10 degrees

2 = 20 degrees

3 = 30 degrees



The temperature is measured from the air entering the rear of the e-Heater.

The colour status LED indicators on the front of the Heater show the status:

Status LED colour	Note
Off	Heater Off
Green x 1	Cooling / recirculation
Green x 2	One heating element
Green x 3	Two heating elements
Green x 4	Three heating elements

4.2 Modul-Connect

When the e-Heater is fitted in conjunction with Modul-Connect the e-Heater can be controlled via additional switch panels fitted in the van and the Modul-Connect phone app.

4.2.1 Phone app

On the start screen, there is a heater widget. On the widget, the current temperature is displayed, and if the heater is running, the target temperature and remaining time is also displayed.

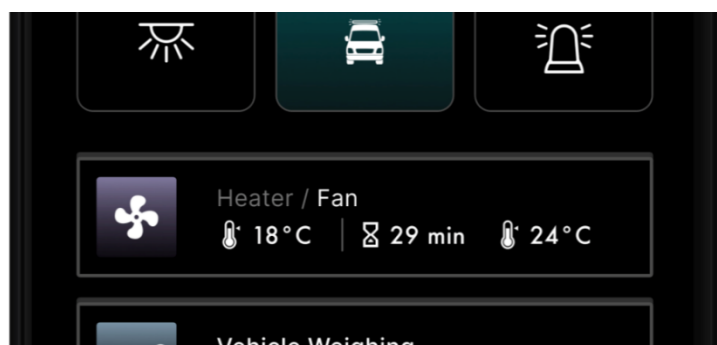

The heater can be started by going into the sub-page of the widget. There run-time and target temperature can be set for the heater. There is also an option of only turning on the fan. At the bottom of the page, there is an option of adding schedule to automatically turn on and off the heater at certain times and days of the week. This is only possible if the Modul-Connect Hub is fitted with an antenna.

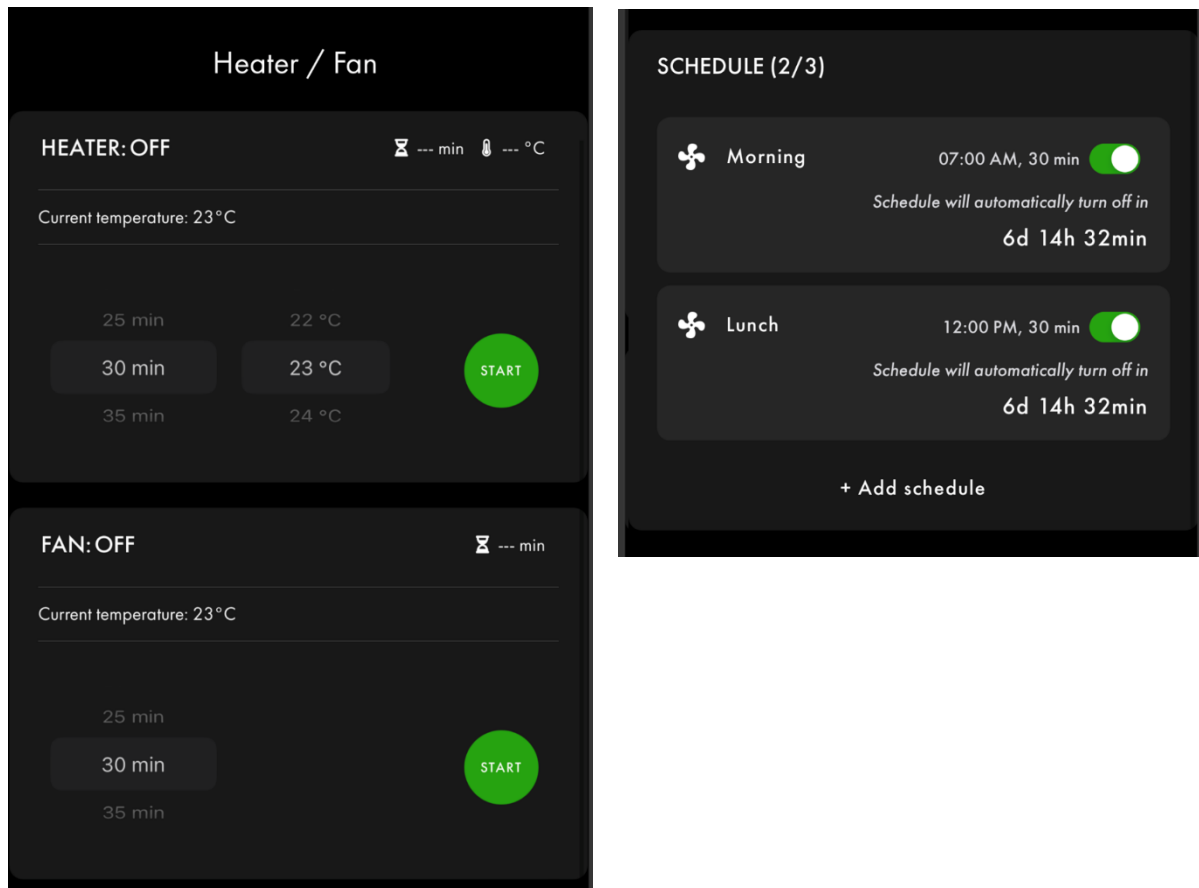

Press the shortcut button at the top, the heater will then start with the previously used target temperature and run for 30 min. If the top switches are greyed out in the app, that means that the phone is not within Bluetooth distance of the vehicle. However, the heater can still be controlled via the widget through the cloud if the Hub is fitted with the antenna.

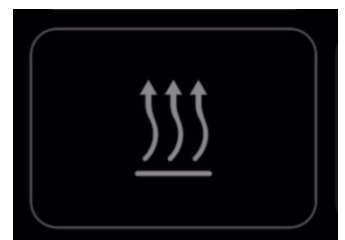

4.2.2 Switch Panels

The 24030-04 Remote Control, 24035-04 Backlit Switch Panel and 24040-04 Display Switch Panel can

be used for controlling the e-Heater. By pressing on the heater switch button, the heater will start with the previously used target temperature and run for 30 minutes.

There are more control options with the 24040-04 Display Switch Panel. By navigate to the heater page in the display, the desired target temperature and run time can be set. If the Modul-Connect Hub is fitted with the antenna, heater schedules can be set via the Display Switch panel. To access the schedules, navigate to the heater page and press on the right arrow.



4.2.3 e-Power

The e-Power has a dedicated heater button to the right of the display. When pressing the heater button, a popup on the display will appear to choose temperature and run-time. The settings can be confirmed with the 'OK' button or the heater button. The heater button will then illuminate green for as long as the heater is running. In the heater menu on the display, schedules can be set for the heater to automatically start at certain times and days of the week.

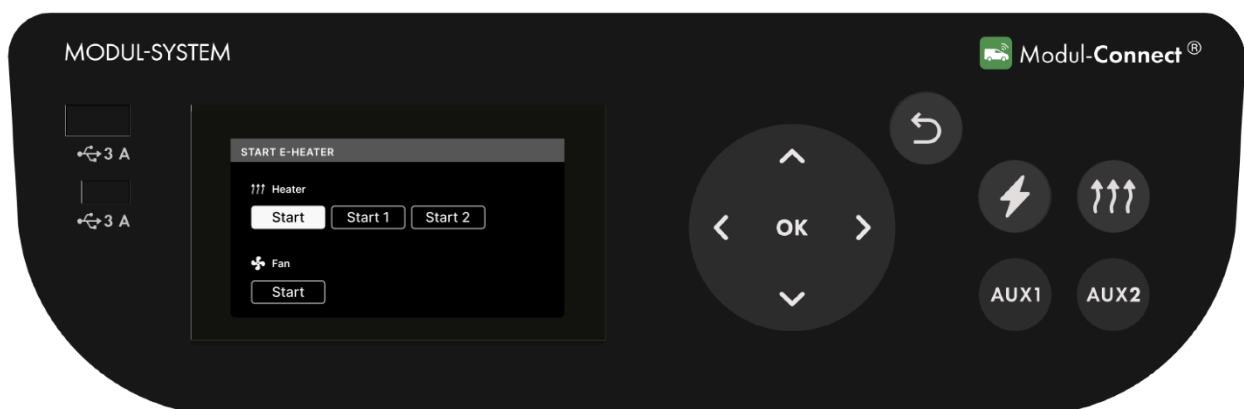

5. Technical Specification

	28410-03 e-Heater 1000	28420-03 e-Heater 2000
Heat output	750W @ +25C 1050W @ -25C	1500W @ +25C 2100W @ -25C
Fan Cool/Recirculate	YES	YES
PTC elements	2	4
Nominal heat Output Temperature	+55C @ -25C ambient +90C @ +25C ambient	+55C @ -25C ambient +90C @ +25C ambient
Operating temperature	-40C - +85C	-40C - +85C
Voltage (Nominal)	12V	12V
Operating Voltage	11-14.5V	11-14.5V
Current Continuous	65A Continuous 88A Continuous	130A Continuous 175A Continuous
Current Inrush	115A	230A
Communication To/From Modul-Connect	CAN 1 (MOLEX Pin 8 &16 + Pin 13 GND)	CAN 1 (MOLEX Pin 8 &16 + Pin 13 GND)
Internal battery guard	10V	10V
Dimensions (LWH)	320 mm x 315 mm x 140 mm	320 mm x 315 mm x 140 mm
Weight	5 kg	6,35 kg
Warrenty	3 year	3 year

6. Warranty

THREE YEAR LIMITED WARRANTY

The limited warranty program is the only one that applies to this unit, and it sets forth all the responsibilities of Modul-System. There is no other warranty, other than those described herein. Any implied warranty of merchantability of fitness for a particular purpose on this unit is limited in duration to the duration of this warranty.

This unit is warranted, to the original purchaser only, to be free of defects in materials and workmanship for two years from the date of purchase without additional charge. The warranty does not extend to subsequent purchasers or users.

Manufacturer will not be responsible for any amount of damage in excess of the retail purchase price of the unit under any circumstances. Incidental and consequential damages are specifically excluded from coverage under this warranty.

This warranty does not apply to damage to units from misuse or incorrect installation/connection. Misuse includes wiring or connecting to improper polarity power sources.

RETURN/REPAIR POLICY:

If you are experiencing any problems with your unit, please contact our customer service department at info@modul-system.com or phone +46 31 746 87 00 before returning product. After speaking to a customer service representative, if products are deemed non-working or malfunctioning, the product may be returned to Modul-System within 30 days of original purchase. Any defective unit that is returned to manufacturer within 30 days of the date of purchase will be replaced free of charge.

If such a unit is returned more than 30 days but less than two years from the purchase date, manufacturer will repair the unit or, at its option, replace it, free of charge. If the unit is repaired, new or reconditioned replacement parts may be used, at manufacturer's option. A unit may be replaced with a new or reconditioned unit of the same or comparable design. The repaired or replaced unit will then be warranted under these terms for the remainder of the warranty period. The customer is responsible for the shipping charges on all returned items.

LIMITATIONS:

This warranty does not cover accessories, such as adapters and batteries, damage or defects result from normal wear and tear (including chips, scratches, abrasions, discoloration or fading due to usage or exposure to sunlight), accidents, damage during shipping to our service facility, alterations, unauthorized use or repair, neglect, misuse, abuse, failure to follow instructions for care and maintenance, fire and flood.

If your problem is not covered by his warranty, contact our Customer Service Department info@modul-system.com or +46 31 746 87 00 for general information if applicable.